

Airthings Wave 2nd gen

Smart Radon Detector







Operating Manual
Version 1, April 5, 2019

Set up your Airthings device in 3 simple steps:

1. Download the Airthings Wave App, available on iOS and Android
2. Create an account and insert Name, Email and Location*
3. Follow the simple instructions in the app to create an account and connect your device

*We securely store your information in the Airthings Cloud.

Many easy ways to contact Airthings

		
Online	By email	Social media
Look at our frequently asked questions, or contact us directly through our support form.	Send an email directly to support at support@airthings.com	Message us on facebook, Twitter, LinkedIn or Instagram!
support.airthings.com		<ul style="list-style-type: none"> Airthings Airthingsglobal Airthings Airthings

Have any questions or comments that we didn't get to here? Please let us know! support.airthings.com

Congratulations on taking this important step toward living a healthier life.

By keeping track of your radon levels, you can make healthier decisions in the spaces where you spend most of your time. Reducing your exposure to radon will reduce your risk of lung cancer.

The Airthings Wave provides you with detailed information about radon, temperature, and humidity levels on your phone, Airthings Dashboard or simply wave in front of the device for a visual indication of your radon levels. Airthings Wave 2nd gen connects using Bluetooth or with the Hub using Airthings SmartLink.

Breathe better, live better,

The Airthings team

Features and content

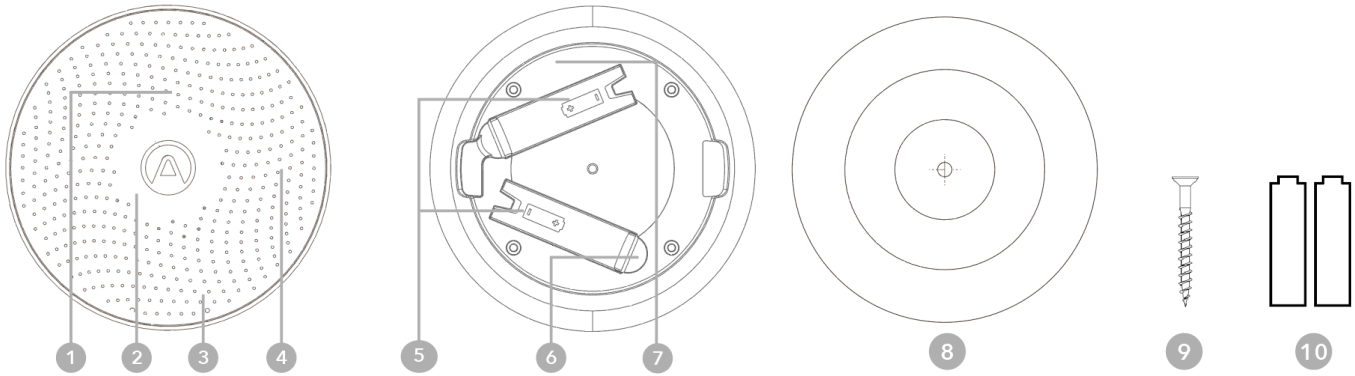

1. Power indicator
2. Glow ring
3. Wave sensor
4. Air inlets
5. Battery compartments (observe polarity symbols)
6. One-time battery tab
7. Individual serial number
8. Mounting bracket
9. Screw
10. 2 AA batteries, inserted

Power indicator

Flashing dot every 20 seconds

Green: battery level okay

Blue: Bluetooth connectivity active

Red: replace batteries

Light ring

Visual indication of your air quality levels.



Green: Good

Yellow: Fair

Red: Poor

(Go to airthings.com/mylevels for more information on air quality action levels)

Air inlets

This is where air comes into your detector.

Audio alarm

The device can give you audio alerts if your radon levels are violating the recommended amount.

Wave sensor

Simply wave in front of your detector to activate the glow ring.

Easy to mount

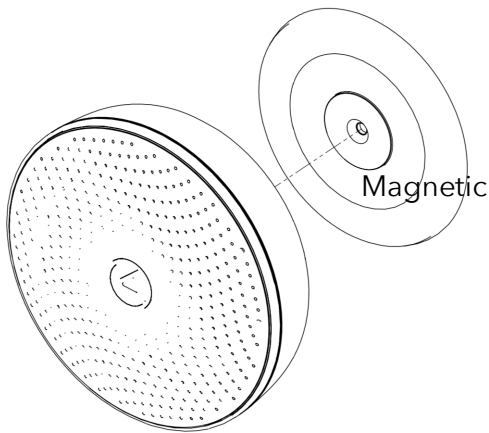

Fix the mounting bracket to the ceiling or wall (optional). Make sure you use an appropriate screw for your wall type. The screw included is intended for wood. Avoid placing your device close to vents or windows (Minimum 1 meter / 3 feet distance).

Thanks to the built-in magnet, simply snap the unit onto the mounted bracket. Then rotate it to the desired position.

Basics of the App

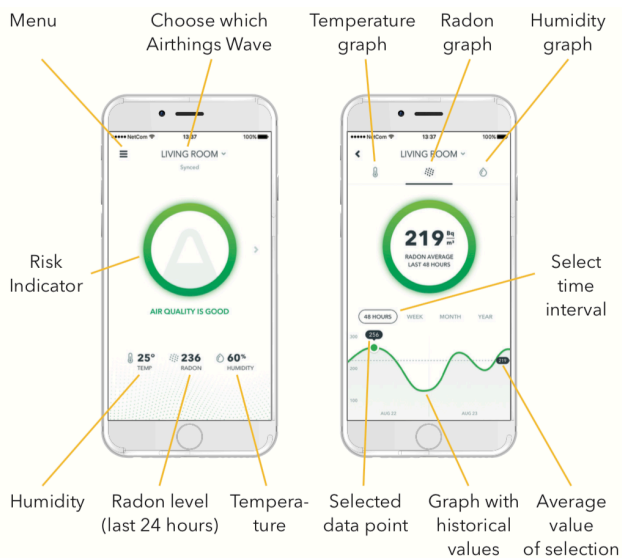

For the U.S.A. radon levels are shown in pCi/L

Daily use

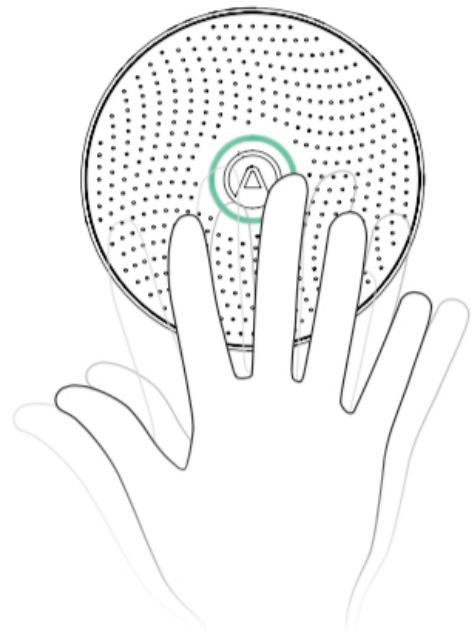

Wave in front of your device to see a visual indication of your daily radon levels.



To download measurement data, open the Airthings Wave app when the phone is within Bluetooth range of your device. The app will search for devices and download historical data.

You will be notified if any actions are needed through the app.

The Airthings Wave 2nd Gen also includes Airthings Smartlink which works with the Hub. Refer to the Hub manual for Smartlink info. The Hub provides longer range as well as live updates using Airthings Smartlink.

Integrations

The Airthings Wave shares data to your mobile device as well as the Airthings Dashboard—a free online platform that provides quick access to view, customize and analyze sensor data from multiple Airthings devices. Go to airthings.com/dashboard for more info.

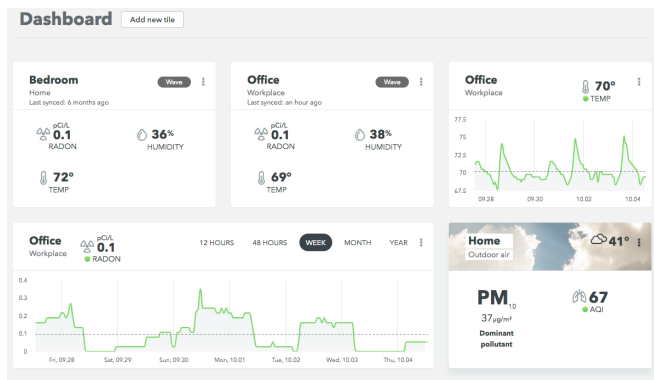

The Airthings Wave is integrated with Amazon Alexa, Google Assistant and IFTTT. With Amazon Alexa and Google Assistant use voice commands to control your device. IFTTT integration allows users to create or access useful recipes for their device to follow and integrate with third-party products. *

Sign up for our newsletter at <https://airthings.com/subscribe> for the latest updates

*Integrations work with last available data synced to cloud.

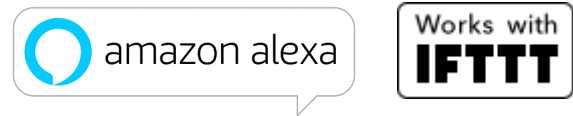

Glow ring

Status	Color	Description
Waiting for first result	White	No air quality assessment is available yet.
Good Indoor Air quality is good Spinning: updating internal firmware	Green	Indoor Air Quality is good and all sensor values are within recommended levels.
Fair Air quality is approaching the recommended limits	Yellow	Indoor Air Quality levels are approaching the recommended level. Take simple steps to bring more fresh air inside and continue monitoring.
Poor Above recommended level and action should be taken to lower your levels	Red	One or more of the sensors are above the recommended level. Actions should be taken to increase ventilation. Check your app or dashboard for details about contaminant levels.

For details on sensor thresholds go to airthings.com/wave

Sensor icons



Radon – Decrease exposure to this radioactive gas that accumulates in buildings and homes. It is the number one cause of lung cancer among non-smokers but can be managed with continuous monitoring.



Temperature – Indoor temperatures can affect performance, mood and comfort level. Individual sleep patterns are also affected by indoor air temperature.



Humidity – Too much or too little humidity can affect allergies and cold or flu symptoms. When humidity levels are high, mold and rot can occur. Low humidity levels cause static electricity, dry skin and hair, and increased susceptibility to colds and respiratory illness.

Troubleshooting

First and foremost, always make sure that you have updated to the latest device software

- In the device settings menu, click update device.

Not able to connect to my device

- Make sure you have the detector within the range of 5 meters or 15 feet.
- Check if Bluetooth is turned on.
- Check if the power indicator is blinking.

Need to turn on the audio alert

- In the app, go to device settings menu and update radon alarm settings.
- Wave in front of the detector to snooze for 1 month when alert is active.

My app is not updated when running in background mode

- Open your phone settings and verify that the Airthings Wave app is running in the background. You can usually find this in the app manager section of your phone settings.
- Make sure you are in Bluetooth range periodically.

No response from glow ring

- Check if the power indicator is blinking.
- If the power indicator is blinking red, or not blinking at all, the battery level is low. First, sync your data and then replace the batteries. We recommend AA alkaline (LR6).

If you need further assistance, read our Frequently Asked Questions, or simply contact support at support.airthings.com.

Technical specifications

Power supply:	2 AA 1.5V alkaline (LR6)
Dimensions:	Diameter: 120 mm (4.72in) Height: 36 mm (1.42in)
Weight:	216g including 2 batteries (7.6 oz)
Operational and storage environment:	Temperature: 4 °C (39 °F) to +40 °C (104 °F)
Radon details:	Initial accuracy/precision at 200 Bq/m ³ (5.4 pCi.L): 7 days ~ 10% (1 std deviation) 2 months ~ 5% Measurement range: 0 Bq/m ³ to 20,000 Bq/m ³ (0 pCi/L to 500 pCi/L)

See more specs in our Wave 2nd gen Product Sheet

Safety and maintenance

The Airthings Wave is intended for indoor use only. Avoid direct exposure to sunlight for long periods. Avoid exposure to direct heat sources. For correct usage, make sure the detector is operating in the specified temperature range (see technical specifications).

Exposure to high humidity might permanently alter the detector sensitivity or damage it.

Do not disassemble. If the detector does not work as specified or you are in doubt, contact your local dealer or visit us at [Airthings.com](https://airthings.com).

Use a dry cloth to clean the detector.

When replacing the batteries, pay attention to the polarity marks. Use AA alkaline (LR6) batteries.

Always snap the mounting bracket to the detector's rear side to protect the batteries, even when the detector is not permanently mounted.

Disposal: electronic equipment.

Limited liability

The device is tested and quality-assured by production. It meets the accuracy values set out in the specifications.

It is recommended to keep the device constantly activated and the batteries in place until drained.

Airthings AS shall not be liable for damages related to failure or loss of data arising from incorrect operations and handling of the device.

Terms & conditions

airthings.com/terms-use-privacy/

For other languages or additional questions go to support.airthings.com

The Bluetooth word mark and logos are registered trademarks owned by the Bluetooth SIG, Inc. and any use of such marks by Airthings is under license.

Copyright Airthings AS 2019

Regulatory information

CAN ICES-3 (B)/NMB-3(B)

This Class B digital apparatus complies with Canadian ICES-003

Cet appareil numérique de classe B est conforme à la norme Canadienne ICES-003

Regulatory information Canada

Changes or modifications not expressly approved by the party responsible for compliance could void the user's authority to operate the equipment.

Les changements ou modifications non expressément approuvés par la partie responsable de la conformité pourraient annuler l'autorisation de l'utilisateur d'utiliser l'équipement.

This device complies with Innovation, Science and Economic Development Canada's license-exempt RSS(s). Operation is subject to the following two conditions: (1) This device may not cause interference; and (2) This device must accept any interference, including interference that may cause undesired operation of the device.

Le présent appareil est conforme aux CNR de l'ISDE applicables aux appareils radio exempts de licence. L'exploitation est autorisée aux deux conditions suivantes : (1) l'appareil ne doit pas produire de brouillage, et (2) l'utilisateur de l'appareil doit accepter tout brouillage radioélectrique subi, même si le brouillage est susceptible d'en compromettre le fonctionnement.

RF exposure safety

This product is a radio transmitter and receiver.

It is designed not to exceed the emission limits for exposure to radio frequency (RF) energy set by the ICSED.

The antenna must be installed and operated with minimum distance of 20 cm between the radiator and your body.

This transmitter must not be co-located or operating in conjunction with any other antenna or transmitter.

Ce produit est un émetteur et un récepteur radio.

Il est conçu pour ne pas dépasser les limites d'émission pour l'exposition à l'énergie radiofréquence (RF) établie par l'ISDE.

L'antenne doit être installée de façon à garder une distance minimale de 20 cm entre la source de rayonnements et votre corps.

L'émetteur ne doit pas être colocalisé ni fonctionner conjointement avec à autre antenne ou autre émetteur.

Regulatory information USA

Changes or modifications not expressly approved by the party responsible for compliance could void the user's authority to operate the equipment.

This device complies with part 15 of the FCC Rules. Operation is subject to the following two conditions: (1) This device may not cause harmful interference, and (2) this device must accept any interference received, including interference that may cause undesired operation.

Class B device notice

NOTE: This equipment has been tested and found to comply with the limits for a Class B digital device, pursuant to part 15 of the FCC Rules. These limits are designed to provide reasonable protection against harmful interference in a residential installation. This equipment generates, uses and can radiate radio frequency energy and, if not installed and used in accordance with the instructions, may cause harmful interference to radio communications. However, there is no guarantee that interference will not occur in a particular installation. If this equipment does cause harmful interference to radio or television reception, which can be determined by turning the equipment off and on, the user is encouraged to try to correct the interference by one or more of the following measures:

- Reorient or relocate the receiving antenna.
- Increase the separation between the equipment and receiver.
- Connect the equipment into an outlet on a circuit different from that to which the receiver is connected.
- Consult the dealer or an experienced radio/TV technician for help.

RF exposure safety

This product is a radio transmitter and receiver.

It is designed not to exceed the emission limits for exposure to radio frequency (RF) energy set by the Federal Communications Commission.

The antenna must be installed and operated with minimum distance of 20 cm between the radiator and your body.

This transmitter must not be co-located or operating in conjunction with any other antenna or transmitter.